

**COVER:**  
A PROGRAMMABLE OSCILLOSCOPE FOR  
PRODUCTION TESTING, page 2

**SEE ALSO:**  
A HIGH-STABILITY, HIGH-SENSITIVITY  
DC SCOPE PLUG-IN UNIT, page 16  
SIMPLER TDR MEASUREMENTS  
pages 9, 10, 12

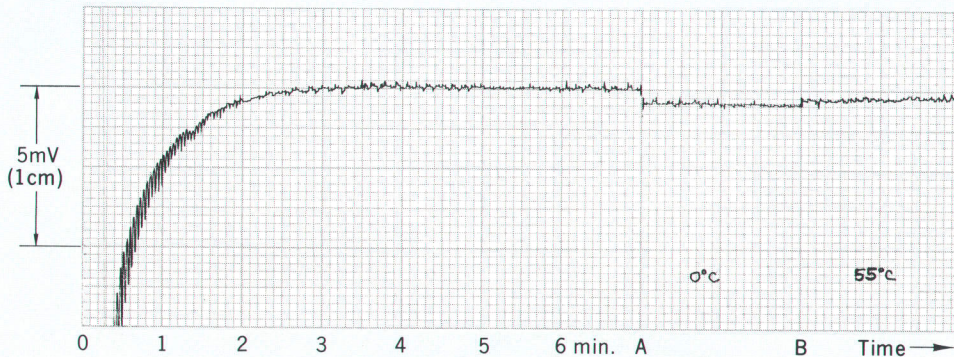

Fig. 1. Recording shows zero stability achieved by dc stabilizer in new Programmable Oscilloscope. Signal for recorder was derived at CRT deflection plates with scope set on 5 mV/cm deflection factor range and shows less than  $\frac{1}{2}$  mV zero level shift with extreme change of temperature. (Trace variations which appear as noise actually are stabilizer switching transients, normally blanked on CRT.) Instrument at room temperature was first turned on at left, and it stabilized in less than 3 minutes. At time 'A', recorder was stopped while instrument was cooled to 0°C before recorder was started again. At time 'B', recorder was stopped once more while instrument was warmed to 55°C and then restarted.

## AN ADVANCED NEW DC-25 MHz OSCILLOSCOPE FOR PROGRAMMED PRODUCTION TESTING

A new oscilloscope has the special capability of maintaining its dc baseline without drift. This leads to higher dc accuracy and the important characteristic of being programmable.

ALTHOUGH CATHODE-RAY OSCILLOSCOPES are widely used because of their versatile measurement capabilities, they are yet to find wide application in automatic test systems. Attempts in the past to provide an oscilloscope with programmable controls have met with

less than complete success primarily because of the inherent drift of sensitive dc-coupled deflection amplifiers. Some means of taking drift into account must be incorporated if programmed displays of waveforms are to achieve a high degree of accuracy.

Now, in a major departure from established concepts, a new oscilloscope resolves the problem of drift by automatically rezeroing itself 3 times a second to correct for both long- and short-term drift in the vertical amplifier. In this oscilloscope, the dc stabilization maintains the baseline at any selected position, thus enabling accurate measurement of waveform levels without requiring the operator to constantly adjust dc levels. It is thus entirely practical to use this instrument in programmable systems, greatly simplifying operating procedures by making unnecessary the need for adjusting instrument controls during the course of a measurement sequence.

The functions of vertical sensitivity, positioning, input coupling, sweep time, trigger source, and trigger slope can all be programmed remotely through a rear input connector, eliminating the danger of measurement

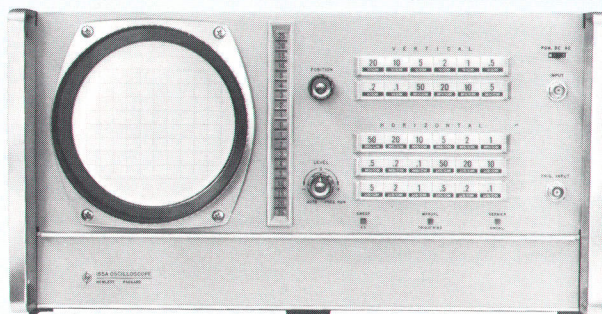

Fig. 2. Model 155A Oscilloscope has dc-stabilized vertical amplifier that eliminates drift. Resulting baseline stability permits use of step-wise Position control to provide wide-range calibrated offset. Selected zero level is shown by illuminated numerals in vertical display. Selected sensitivity and sweep time ranges are indicated by illumination of numerals in appropriate pushbuttons.

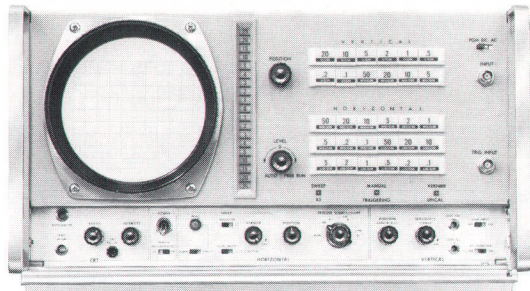

Fig. 3. Controls needed for complete manual control of oscilloscope are available behind flip-down cover. Only those controls necessary for readout of programmed ranges and for manual search for signal, when in programmed operation, remain exposed when cover is closed.

errors resulting from operator selection of the wrong range. Hence, in programmed systems where repeated sequences of tests are made, such as in production testing, this oscilloscope makes it possible for less-skilled personnel to use an oscilloscope with uniformly accurate results.

The stabilizing technique also permits the instrument to make reliable measurements of dc levels with analog voltmeter accuracy. In situations where several types of measurements are made, the new scope may be used in place of other instruments to measure dc levels, as well as waveforms, with complete confidence. The virtually complete absence of variations in the dc level of the vertical amplifier, even

in the face of ambient temperature changes, is shown by the recording of Fig. 1.

In addition to enabling dc measurements ordinarily not attempted with an oscilloscope, the stabilized vertical amplifier allows accurate offset of the baseline in calibrated increments above or below the center of the CRT graticule. In view of this capability, the vertical deflection amplifier was designed with a wide dynamic range which, along with the wide offset range ( $\pm 25$  cm), allows expanded scale measurements to be made. With offset, small ac signals riding on a relatively large dc may be examined in detail even though dc coupling is retained. Waveforms may be expanded several times

beyond full scale for detailed examination of any part of the waveform, as shown in Fig. 4.

#### WIDE RANGE SCOPE

Apart from its stable dc operation, the new oscilloscope (*-hp-* Model 155A) is capable of high performance in many other respects. It is basically a general purpose, wideband, single-channel oscilloscope with a high-frequency 3-dB point at 25 MHz (Y axis), a response figure that is referred to an 8-cm display rather than the 6-cm reference usually used for scopes with bandwidths higher than 10 MHz. Rise time is less than 15 nanoseconds for 8-cm deflection and less than 20 nanoseconds with pulses that have amplitudes expanded considerably beyond the 8-cm display area. Minimum deflection factor (maximum sensitivity) is 5 mV/cm. Unmagnified sweep times range down to 0.1  $\mu$ s/cm and a  $\times 5$  magnifier is included for expanded sweeps. The scope is thus well-suited for critical laboratory applications as well as programmed testing, bringing the accuracy and convenience of drift-free performance to the lab bench.

#### PUSHBUTTON OPERATION

Only the most commonly-used controls of the new oscilloscope are visible to the user during normal programmed operation, but all other controls that are standard for a general-

Fig. 4. Oscillograms illustrate waveform magnification made possible by wide dynamic range and offset positioning of new Model 155A Oscilloscope, even for fast-rise waveforms. Upper photo shows square-wave generator output (ac-coupled) at sweep speed of 400 ns/cm. Lower photo is of same waveform expanded 10 times to 50 cm with center line offset 25 cm to show only top of waveform. Note in lower photo that expanded waveform drives trace to equivalent of  $-50$  cm with negligible loss of rise time or fidelity. New scope thus has dynamic range of 50 cm above and below zero reference level or a total of 100 cm.

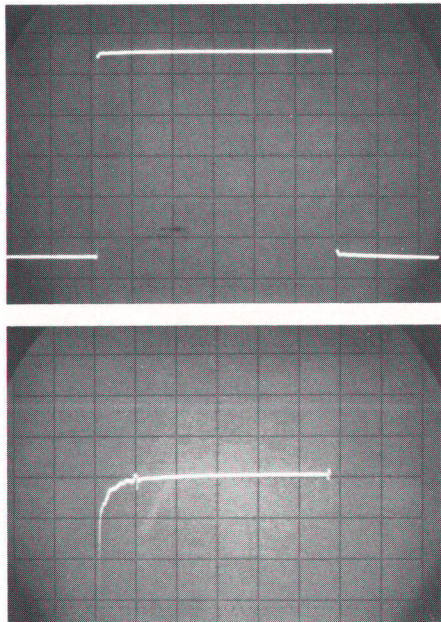

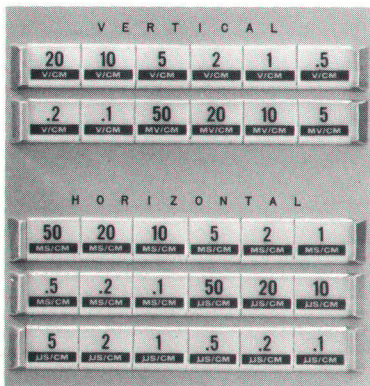

Fig. 5. Vertical deflection factor and horizontal sweep rate on new oscilloscope are selected manually by pushbuttons or remotely by contact closures to ground. Lamps inside pushbuttons indicate selected ranges in either manual or remote operation.

purpose laboratory oscilloscope are located behind a hinged door along the bottom of the front panel (Fig. 3). Concealing these controls reduces the danger of misadjustment by the semi-

skilled operator but with the door lowered, the controls are readily available to the trained operator.

In the manual mode of operation, vertical sensitivity and sweep time are

controlled by momentary-contact, illuminated pushbuttons for quick selection of ranges. Stepped vertical positioning is controlled by a front panel knob and the zero-voltage level is indicated on an illuminated front panel display (Fig. 9), an especially desirable arrangement for expanded scale measurements when the baseline may be positioned off the screen. All other functions are controlled by conventional knobs and switches.

### PROGRAMMED OPERATION

In the programmed mode, all programming of the instrument is digital and is accomplished by contact closures to ground, thereby placing a minimum

## ELIMINATING DC DRIFT

In the new oscilloscope described in the accompanying article, the dc level of the amplifier is stabilized approximately 3 times a second. During the stabilization interval, a sequence generator disconnects the input signal and the vertical positioning voltage from the amplifier, grounds the amplifier input, and samples any difference of potential that may be present at the vertical deflection plates. Normally, the deflection plates should be at some prescribed potential when the input is grounded; any other potential difference represents drift.

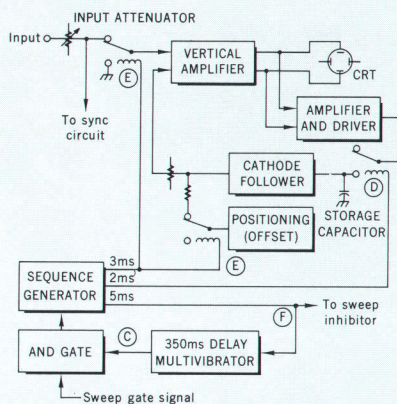

Fig. 1. Simplified block diagram of dc stabilization circuit. During sampling interval, drift sensed at CRT deflection plates, while amplifier input is grounded, charges storage capacitor. Between sampling intervals, stored capacitor voltage is applied to amplifier input to provide offset that cancels drift-induced changes in dc level.

Charge representing the potential difference is stored in a capacitor and held there until the next sampling interval. Between samples, when the input signal is connected to one input of the differential amplifier, the signal at the opposite input is the sum of a correction signal, derived from the stored capacitor voltage, and the position signal introduced to offset the trace vertically. The correction voltage provides an offset that compensates for any drift.

The stabilizing system takes advantage of the dead time during flyback of the horizontal sweep. The stabilizer cycle is started by a signal from an AND gate that senses inputs from both the sweep gate and a delay multivibrator (see block diagram, Fig. 1). The conditions for taking a sample are that it has been longer than 350 milliseconds since the last sample, as determined by the delay multivibrator, and that an ensuing sweep has been completed, as signaled by the sweep gate. These are shown as waveforms A, B, and C in Fig. 2.

The switching functions are controlled by the sequence generator, a monostable multivibrator that is triggered by the signal from the AND gate. The sequence generator has three outputs with three distinct 'on' times. The 2-millisecond output controls the sampler reed switch which closes the correction feedback loop (waveform D). The 3-millisecond output drives the reed switches that disconnect the input and positioning signals and that reference the amplifier input to ground (waveform E). These switches are held closed 3 milliseconds to insure that the correction loop is opened again before anything is done that might disturb the reference to which the amplifier is stabilized. The 5-millisecond output inhibits the sweep generator, the additional 2 milliseconds allowing time for the amplifier to recover from any switching transients before the display is again presented on screen (waveform F).

The output of the amplifier that senses drift is coupled through an emitter-follower to the storage capacitor in the stretcher or zero order hold. The emitter-follower serves as a low-impedance driver for charging the capacitor.

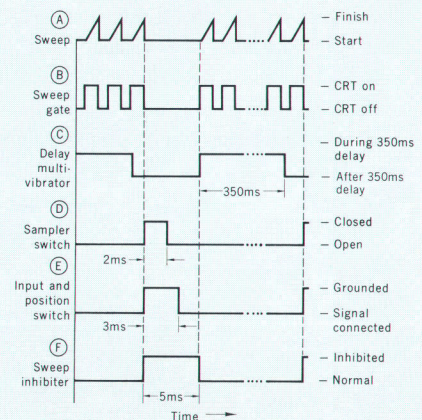

Fig. 2. Waveforms show sequence of events during stabilization interval. Stabilization starts during fly-back time of horizontal sweep and further operation of sweep generator is inhibited until stabilization cycle is completed.

The output from the zero order hold is then fed through a cathode follower to an attenuator and mixing circuit and then into the normally undriven input of the main vertical differential amplifier.

The forward gain of the vertical amplifier with the correction loop open is about 2000 at maximum amplifier sensitivity. During the time the loop is closed, the gain is reduced to 10 by the return ratio of 200. The net result is that the correction reduces any drift by the return ratio. With correction, the vertical amplifier, with its minimum deflection factor of 5 mV/cm, has a drift characteristic that compares with an uncorrected amplifier having but 1 V/cm deflection factor. The stabilized amplifier maintains a zero offset baseline within plus or minus 0.1 centimeter of center screen, after less than a three-minute warmup, and it is virtually unaffected by environmental tem-

number of requirements on the programming device. The oscilloscope can be programmed by a wide variety of digital devices such as computers, punched cards, and stepping switches.

A total of 35 program lines provide full programming capability. A maximum of 9 contact closures are required at one time for each program, depending on the functions to be programmed. Vertical deflection factor and sweep time require two each. Vertical offset requires two closures, with one determining the amount of offset and the other determining polarity, and vertical input coupling (ac or dc) requires a single closure. Trigger source signal selection requires a single

perature changes. The strip chart recording on page 2 shows the very low level of variations caused by temperature changes.

The stabilizer system responds to and corrects for any drift or low frequency noise occurring at a frequency lower than 3 Hz. The response of the system in correcting for drift that might have occurred since the last sample is readily measured by disabling the sequence generator, holding the feedback loop closed, and feeding a low-frequency step into the vertical amplifier signal in place of referencing it to ground. The resulting CRT display shows the response characteristic and correction time. Fig. 3 is such a display showing the correction for two amplitudes and for both polarities.

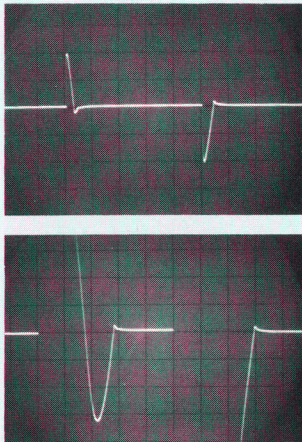

Fig. 3. Oscillograms show response of stabilizer to step change in zero level. Upper waveform resulted from 2-cm step which was corrected in 0.1 ms. Lower waveform resulted from 20-cm step, corrected in 0.6 ms. Both steps were corrected to same level, even though trace was driven far off screen in lower photo. Sweep speed in both oscillograms is 0.2 ms/cm and vertical deflection factor is 5 mV/cm.

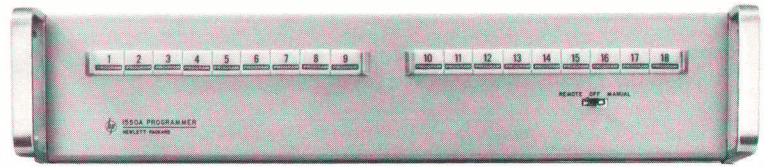

Fig. 6. Companion Programmer stores 18 programs for control of oscilloscope. Each program, selected by one pushbutton or one external contact closure, sets six oscilloscope functions. Programmers may be cascaded to provide greater number of programs.

closure to select internal, external, or line. Trigger slope needs one closure to select the positive or negative slope of the signal for initiating triggering.

Each open program line has a  $-12\text{-V}$  potential on it and any switching device capable of sinking at least 20 milliamperes to ground can be used for programming (power for programming is supplied by the scope main frame). An isolated ground line is supplied to the program input connector so that a front panel switch may be used to disable all program inputs should this requirement arise.

#### PROGRAMMER

A companion instrument, the *-hp-* Model 1550A Programmer, provides the means for storage and selection of programs for the oscilloscope controls. The Programmer (Fig. 6) allows each preset program to be selected in any order either manually by one of the pushbuttons on the Programmer, or remotely by a single contact closure. The Programmer thus may serve as a storage buffer for system programmers.

Switching to a new program requires about 10 milliseconds. The selected program is indicated by a light in the appropriate pushbutton on the Programmer and lights in the oscilloscope pushbuttons indicate the ranges being programmed.

Programs are established by diode pins that plug into a matrix on a circuit board in the Programmer (Fig. 7). Up to 18 complete preselected programs may be stored and selected by one Programmer and Programmers

may be cascaded to increase the number of programs by multiples of 18.

The Programmer has one auxiliary programming line that normally is not used for any of the scope functions. This line, useful for additional programming instructions, may be programmed 'off' or 'on' by appropriate insertion of a diode pin connector.

As shown by the circuit diagram of Fig. 8 the Programmer uses external power and it may be used as a controller for other equipment that is compatible with the Programmer's logic level and power requirements.

#### TRANSFER OF CONTROL

While the instrument is being operated from programmed instructions, any of the pushbuttons may be operated manually to override the program when the need arises to search for a signal or otherwise deviate from a standard program sequence. This is important in production testing or system checkout if a manual search for the signal is required at times when the waveform to be measured does not appear on the scope display because of a malfunction or misalignment of the equipment under test. To restore programmed operation, resetting the previous program or switching to a new one is all that is required.

To facilitate transfer of control between programmed and manual operation, the vertical deflection factor and sweep time control inputs, either manual or programmed, are stored in a memory in the oscilloscope. The memories consist of multistable multivibra-

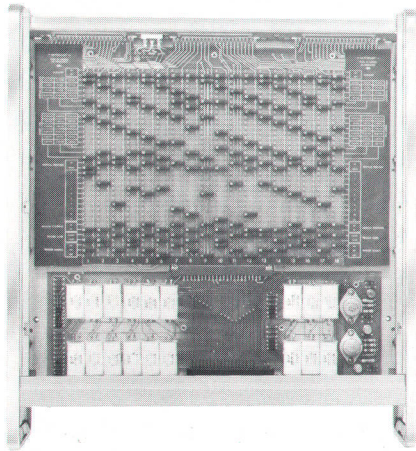

Fig. 7. Oscilloscope functions are quickly set up in Programmer by insertion of diode pin connectors in appropriate holes. Each column represents one program. Legends at left and right indicate functions selected by corresponding levels in column.

tors which control reed relays. The sweep time memory, for example, consists of a six-stable multivibrator and a three-stable multivibrator. Two bits of information are used simultaneously to establish a particular sweep time, one bit representing the sweep decade and the other representing the 1-2-5 sequence. The memory output provides the selection of the proper integrator resistor and capacitor to set the slope of the horizontal time base ramp and it also provides the proper outputs to turn on the neon that indicates the range.

Depressing a pushbutton in the sweep time array on the front panel overrides a program input by supplying a dc input to set the multistable multivibrators. This manually-introduced signal overrides any previous input and holds the memory in the new state until either another manual or a programmed input is received.

The memory for the vertical sensitivity is basically the same as the sweep time except that it has seven bits of storage arranged in a four-stable and three-stable multivibrator configuration to provide outputs for the 12 sensitivity ranges.

Adequate protection from externally

generated noise pulses is necessary since any noise that might be coupled into programming lines could cause erroneous ranges to be set up. Instead of using the input from the programming device to generate the programming signal directly, each input is buffered by a reed relay. The Program input then energizes the reed relay which in turn generates the switching signal. Noise impulses of sufficient energy to close a relay are not usually encountered.

For applications not requiring programmability, the oscilloscope can be operated without the circuit cards required by external inputs. These cards and associated cabling may be added at any later time should a requirement for programmability arise.

#### VERTICAL OFFSET

The new oscilloscope allows either discrete-step or continuous control of vertical positioning. Calibrated step control, coupled with dc stabilization, is necessary for programmed operation to insure accurate and repeatable measurements of waveforms. The step control permits offset of the baseline in 1-centimeter steps up to plus or minus 5 centimeters, and then in 5-centimeter steps up to plus or minus 25 centimeters. The dividers in which these voltages are derived have resistors of  $1/2\%$  accuracy to insure that the offset signal is accurate to better than  $2\%$ . The steps may be selected manually by the front panel control as well as remotely in the programmed mode of operation.

A manually-operated vernier behind the hinged cover allows continuous control of positioning to approximately 3 centimeters above and below any digital setting.

A digital circuit associated with the position control establishes either programmed or manual operation. A programmed input automatically sets the circuit to accept this type of control. To switch to the manual mode of operation, the operator need only change the position switch setting and manual operation is automatically established. Control of the offset then remains in the manual mode until either the previous program is reset or a new program is selected.

#### VERTICAL AMPLIFIER

The vertical amplifier, exclusive of the dc stabilization circuits, is differential throughout. The circuitry is solid-state except for Nuvistors in the input stage, which provide the high impedance and low-leakage characteristics required for a 1-megohm input resistance. The input attenuator uses specially shielded reed relays and tight tolerance resistors to provide good high frequency response and an accuracy of  $\pm 2\%$ . Input capacitance is held constant at approximately 50 pF.

The low-level stages of the amplifier are designed for linear operation with signal amplitudes that would cause deflection of greater than  $\pm 50$  centimeters. The output stage and driver have fast diode clamping circuits that prevent large signals from saturating the transistors, thus enabling expanded scale displays without creating distortion in the visible part of the display.

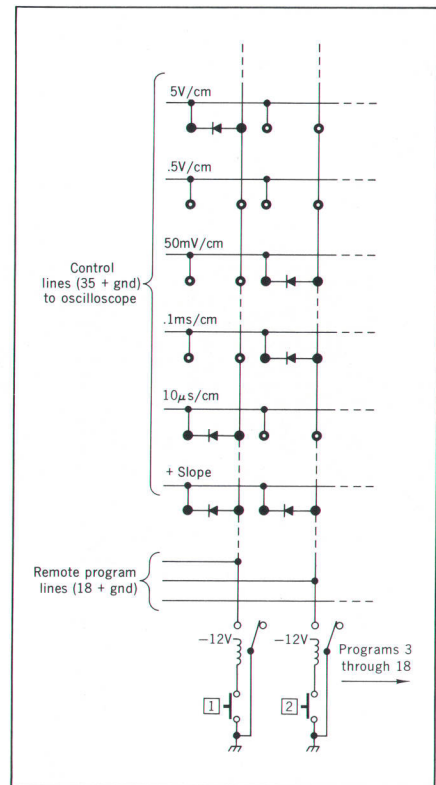

Fig. 8. Each pushbutton in Programmer controls relay that grounds all program lines for relays on corresponding program lines in oscilloscope (diodes decouple lines from programs other than that being activated). Single external closure to ground also activates all program lines in corresponding program.

Delay lines in the amplifier retard the signal 200 ns to permit display of the leading edge of fast rising waveforms while the same waveform is used to trigger the sweep.

#### TRIGGERING

The trigger signal is derived at a point between the vertical input atten-



Fig. 9. Position of zero level baseline selected by Positioning control is indicated by illuminated numerals, enabling measurement of dc levels with analog voltmeter accuracy even with zero level displaced up to  $\pm 25$  cm from center screen.

uator and the amplifier input and it is applied to a separate, high-performance ac-coupled differential amplifier. No trigger amplification takes place in the vertical deflection amplifier itself because of the switching transients generated during the stabilization cycle, which would affect synchronization adversely.

In the absence of an input signal, the time base trigger system automatically generates triggers at about 30 Hz thus assuring a continuous display of the base line. This is especially convenient when the oscilloscope is used as a voltmeter to measure dc levels. When the triggering control is switched to 'Auto', the trigger level is preset for optimum triggering on most waveforms. However, trigger level may be adjusted manually by a front panel control located on the front panel outside and just above the enclosed panel where it is readily available to the user if needed.

#### CRT AND Z-AXIS

The CRT used in the new oscilloscope provides a bright display on an 8 x 10 centimeter area and it has an internal graticule which eliminates

parallax error in the reading of waveform amplitudes. The tube is a post-accelerator type using a mesh electrode and an overall accelerating potential of 7.5 kV. The vertical deflection factor of the tube is 8.5 volts/cm, and the horizontal deflection factor is 12.5 volts/cm making the tube compatible with solid-state amplifiers. The longer persistence provided by P2 phosphor is used to suppress stabilization flicker.

The Z-axis or intensity modulation amplifier is a direct-coupled operational amplifier. Z-axis input signals from dc to rise times faster than 60 ns may be displayed on the CRT.

#### ACKNOWLEDGMENTS

Electrical design of the -hp- Model 155A/1550A Oscilloscope was by Roy Wheeler and Charles House; product design was by Norman Overacker, Thomas Schroath, and Philip Foster. The author wishes to extend a note of gratitude to Norman Schrock of the -hp- Oscilloscope Division for his support and encouragement during the project.

— John Strathman  
Project Leader

#### DESIGN LEADERS



CHARLES HOUSE



NORMAN OVERACKER



JOHN STRATHMAN

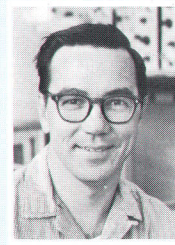

ROY WHEELER

Chuck House joined -hp- in 1962 after earning his BSEE degree from the California Institute of Technology. Two years later he earned his MSEE degree from Stanford University in the -hp- Honors Cooperative Program. At -hp-, Chuck initially worked as a development engineer on the 140A Oscilloscope and then on the design of the vertical amplifier in the Model 155A Oscilloscope.

Norm Overacker started with -hp- in 1957 on a part-time basis while participating in a cooperative work-study program at San Jose State College. Initially, he worked as a mechanical assembler, a pro-

duction-line test technician, and as a service department repair technician. After earning his BSEE degree in 1962, Norm joined -hp- full time as a service engineer but transferred to the -hp- Oscilloscope Division in 1963 where he has been a product design engineer on the 155A/1550A Programmable Oscilloscope project. Norm also taught courses in basic electronics and electronic circuits at the College of San Mateo, California.

John Strathman joined -hp- in 1957 as a development engineer. Initially, he participated in the development of the Model 120A Low Frequency Os-

cilloscope and was then project leader for development of the Model 122A Dual Trace Oscilloscope and the 130C Sensitive Oscilloscope. He was also project leader on several plug-ins for the 160B/170A Militarized Oscilloscopes, including the 166C Display Scanner, the 162D High Gain Amplifier, and the 162F Wide Band Amplifier. John presently is manager of low frequency and special purpose oscilloscope development in the -hp- Colorado Springs laboratory.

John received his BSEE degree from the University of Illinois in 1955 and his MSEE degree from Stanford Univer-

sity in 1960 in the -hp- Honors Cooperative program. He is a member of IEEE, Tau Beta Pi, Theta Kappa Nu, Sigma Tau, and Pi Mu Epsilon.

Roy Wheeler worked for seven years in product design prior to obtaining a BSEE degree from the University of Illinois in 1963. He then joined -hp- as a development engineer doing circuit design for various sections of the 155A/1550A Programmable Oscilloscope. Roy, who is a member of Beta Kappa Nu, has done graduate work at the University of Colorado.

## SPECIFICATIONS

### -hp- MODEL 155A OSCILLOSCOPE

#### VERTICAL DEFLECTION SYSTEM

**DEFLECTION FACTOR (SENSITIVITY):** 12 calibrated ranges from 5 mV/cm to 20 V/cm in 1, 2, 5, 10 sequence. Vernier allows continuous adjustment between calibrated ranges and extends deflection factor to at least 50 V/cm.

**ATTENUATOR ACCURACY:**  $\pm 2\%$ .

**BANDWIDTH** (referred to 8-cm signal at 1 MHz from 25 $\Omega$  source):

DC coupled: DC to greater than 25 MHz at 3 dB down.

AC coupled: 2 Hz to greater than 25 MHz at 3 dB down.

#### RISE TIME:

Less than 15 ns at 8 cm reference signal.

Less than 20 ns at 25 cm reference signal. (With 25 $\Omega$  source having rise time  $\leq 3$  ns.)

**POSITION:** Base line can be offset  $\pm 25$  cm from center screen of CRT in calibrated 1-cm steps from 0 to 5 cm and 5-cm steps from 5 to 25 cm. Accuracy of steps is  $\pm 2\%$  when amplifier gain is calibrated. Vernier allows continuous  $\pm 3$  cm adjustment about setting of step offset.

**DC STABILITY:** Zero-setting dc stabilization maintains zero offset base line within  $\pm 0.1$  cm of center screen on CRT over entire sensitivity range after 3-minute warm-up. Zero setting occurs approximately 3 times per second.

**SIGNAL DELAY:** Signal is delayed so that leading edge of fast rise signal is visible at start of sweep.

**INPUT IMPEDANCE:** 1 megohm shunted by  $\approx 50$  pF.

**MAXIMUM INPUT VOLTAGE:** 400 volts (dc + peak ac).

**REAR INPUT:** Rear panel BNC input connector is selectable by front panel switch. Input impedance is 1 megohm shunted by approximately 80 pF. Bandwidth is greater than 20 MHz, rise time less than 18 ns for 8 cm step.

**REAR OUTPUT:** Rear-panel BNC connector provides low-impedance dc-coupled vertical signal output corresponding to on-screen display. With stabilizer operating, output signal is dc-stabilized and contains 5-ms stabilizer switching transient at  $\approx 3$  Hz. DC level  $-1.7$  V at center screen. Output amplitude  $\approx 170$  mV/cm.

Dynamic range greater than CRT graticule display.

Bandwidth  $\approx 25$  MHz.

(Above with output terminated into 50 $\Omega$ .)

#### HORIZONTAL DEFLECTION SYSTEM

**INTERNAL SWEEP:** 18 calibrated ranges from 0.1  $\mu$ s/cm to 50 ms/cm in 1, 2, 5, 10 sequence. Accuracy is typically within 1%, always within 3%. Vernier allows continuous adjustment between calibrated ranges and extends slowest sweep to at least 0.125 s/cm.

**MAGNIFICATION:**  $\times 5$  expansion on all ranges extends fastest sweep to 20 ns/cm. Accuracy is typically within 3%, always within 5%.

**SLOW SWEEPS:**  $\div 10$  slows 10, 20 and 50 ms/cm sweeps to 0.1, 0.2, and 0.5 s/cm, respectively. Accuracy is typically within 3%, always within 5%.

#### TRIGGERING:

**AUTOMATIC:** Base line displayed in absence of input signal.

**INTERNAL:** 40 Hz to greater than 25 MHz from signals causing 0.5 cm deflection or more from 50 mV/cm to 20 V/cm and from signals causing 2.0 cm deflection or more from 5 mV/cm to 20 mV/cm deflection factor; also from line voltage.

**EXTERNAL:** 40 Hz to greater than 25 MHz from signals 0.5 volt to 10 volts peak-to-peak. Input impedance: 100 k shunted by approximately 20 pF.

**TRIGGER SLOPE:** Positive or negative.

#### AMPLITUDE SELECTION:

**INTERNAL:** Same as Automatic Internal except lower cutoff frequency extends to 10 Hz.

**EXTERNAL:** Same as Automatic External except lower cutoff frequency extends to 10 Hz.

**TRIGGER POINT AND SLOPE:** Internally from any point on displayed waveform; externally from any point between  $\pm 5$  volts, positive or negative slope.

**SINGLE SWEEP:** Front panel switch selects single sweep operation.

#### REMOTE PROGRAMMING

Programming is accomplished by contact closures to isolated common line. Control lines are at  $-12$  volts and closure current is approximately 20 mA. Programmable functions are listed below:

##### VERTICAL:

**DEFLECTION FACTOR (SENSITIVITY):** 12 ranges from 5 mV/cm to 20 V/cm in 1, 2, 5, 10 sequence. Seven control lines, two used per program.

**INPUT COUPLING:** ac or dc, one control line.

**VERTICAL POSITIONING:**  $\pm 1 - 5, \pm 10, \pm 15, \pm 20, \pm 25$  cm and zero, 12 control lines, two used per program.

##### HORIZONTAL:

**SWEEP TIME:** 18 ranges from 0.1  $\mu$ s/cm to 50 ms/cm in 1, 2, 5, 10 sequence. Nine control lines, two used per program.

**TRIGGER SOURCE:** Internal, external, or line frequency. Three control lines, one used per program.

**TRIGGER SLOPE:** Plus or minus. Two control lines, one used per program.

**PROGRAM INPUTS:** Control lines available at rear panel connector with power to operate Model 1550A Programmer.

**MANUAL OPERATION:** When oscilloscope is remotely programmed, manual function selection is accomplished by switching to desired range. Programming is restored by switching to new program or resetting previous program.

#### GENERAL

**CALIBRATOR:** 1-volt peak-to-peak line frequency square wave available at front panel. Accurate to  $\pm 1\%$ ,  $+15$  to  $+35^\circ\text{C}$ , and to 3%, 0 to  $55^\circ\text{C}$ . Rise time is 0.5  $\mu$ s or less.

**INTENSITY MODULATION:** Approximately  $+20$  volts required to blank trace of normal intensity. DC coupled input is located on rear panel. Input resistance approximately 22k. Rise time less than 60 ns.

**CATHODE RAY TUBE:** 7.5-kV post-accelerator tube with aluminumized P2 phosphor. P7, P11, P31 phosphor available, no charge.

**ACCESSORIES FURNISHED:** Model 10001A 10:1 divider probe, plug-in printed circuit extender board, mating connector for programming connector.

**POWER:** 115 or 230 volts, 50 to 60 Hz, approximately 200 watts.

**DIMENSIONS:** 16 $\frac{3}{4}$  in. wide, 9 in. high, 18 $\frac{3}{8}$  in. deep over-all (426 x 229 x 466 mm).

**WEIGHT:** Net, 45 lbs.

**PRICE:** \$2,450.00

Option 01: without programming capability, \$2,150.00.

Prices f.o.b. factory

Data subject to change without notice.

## SPECIFICATIONS

### -hp- MODEL 1550A PROGRAMMER

Programmer provides means for programming vertical sensitivity, vertical positioning, vertical input coupling, sweep time, trigger source, and trigger slope in Model 155A Programmable Oscilloscope, plus an auxiliary single line function, and includes means for selecting any of the preset programs.

**PROGRAM STORAGE:** Up to 18 different programs may be stored. Additional output connector for control lines is provided on rear panel to permit cascading of programmers for additional program storage if desired.

**PROGRAM SELECTION:** Front panel switch permits selection of three operating modes: manual, remote, and off.

**MANUAL PROGRAMMING:** Preset programs are selected in any order by momentary-contact, illuminated pushbuttons on Programmer front panel.

**REMOTE PROGRAMMING:** Programs may be selected externally by making a single contact closure to isolated ground (external switching must provide 10-ms break-before-make contact closures and contacts must switch maximum of 300 mA). Program control lines are available at rear panel connector. Externally selected programs are identified by illuminated readout on front panel.

**OFF:** Programmer can be disabled when manual-only operation of oscilloscope is desired regardless of Programmer switching.

**PROGRAMMING PINS:** Programs are preselected by inserting diode pins in 15 in. x 10 in. pin board. Extra diode pins included for one auxiliary function per program.

**POWER REQUIREMENTS:** Power required by Model 1550A is supplied by Model 155A Oscilloscope. Minus 12 volts for auxiliary function is supplied at rear panel; current for auxiliary function is limited to 50 mA.

**DIMENSIONS:** 15 $\frac{3}{4}$  in. wide, 31 $\frac{1}{2}$  in. high, 18 $\frac{3}{8}$  in. deep.

**WEIGHT:** Net, 12 lbs.

**ACCESSORIES FURNISHED:** Model 10129A Interconnecting Cable to Model 155A Oscilloscope, 3 ft. long. Mating connector for remote programming connector.

**ACCESSORIES AVAILABLE:** Model 10130A Interconnecting Cable to Model 155A Oscilloscope, 10 ft. long. Special length interconnecting cables available upon request.

**PRICE:** \$600.00

Prices f.o.b. factory

Data subject to change without notice.



# TIME DOMAIN REFLECTOMETRY IN 75-OHM SYSTEMS

THE *-hp-* TDR SYSTEM<sup>1</sup> has a characteristic impedance of 50 ohms because this is the most common impedance for cables and microwave systems. There are, however, other common impedances, and in the communication industries, in television broadcasting, and in community-antenna television systems, 75 ohms is widely used.

Calibration and interpretation of the TDR display are simplest when the characteristic impedance of the TDR system is the same as the characteristic impedance of the system being tested. The reason for this is that, when these impedances are matched, energy reflected from the system being tested is terminated in the proper impedance, and no re-reflections occur at the source.

The *-hp-* TDR system can now be converted easily for testing 75-ohm systems by means of new 50-to-75-ohm adapters recently developed by the *-hp-* Colorado Springs Division (Fig. 1).

The adapters are 25-ohm resistors with connectors which are compatible with the *-hp-* TDR system and with common 75-ohm systems. Fig. 2 is a schematic diagram of a typical TDR setup for testing a 75-ohm cable. Energy returning to the TDR system from the cable is properly terminated in 75 ohms by the series combination of the 25-ohm adapter and the 50-ohm TDR system. There is no source mismatch to cause re-reflections.

Fig. 3 is a photograph of the TDR display for the setup of Fig. 2 with an

<sup>1</sup> *-hp-* Model 1415A TDR Plug-in for the *-hp-* Model 140A Oscilloscope.

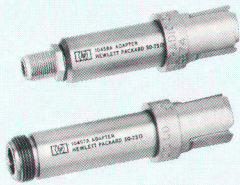
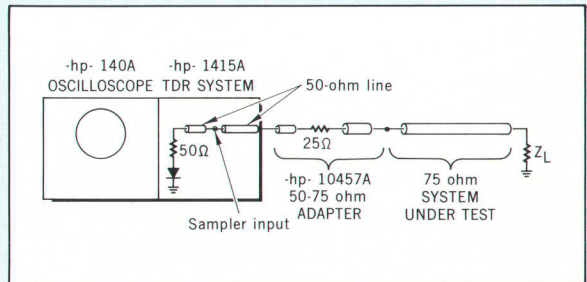

Fig. 1. New *-hp-* Models 10457A-8A 50-to-75-ohm adapters simplify testing of 75-ohm systems with *-hp-* Model 1415A Time Domain Reflectometer. Adapters are 25-ohm resistors with one GR874 connector and one type 'N' or 'F' connector.

Fig. 2. Block diagram of setup for TDR testing of 75-ohm system using new 50-to-75-ohm adapter. Energy reflected from 75-ohm system is properly terminated by series combination of 25-ohm resistor (adapter) and 50-ohm TDR system, thereby eliminating source re-reflections.



open circuit at the end of the 75-ohm cable ( $Z_L = \infty$ ). The display shows an initial mismatch at point 'A', which is the result of the 50-ohm TDR system's being terminated in the 100-ohm series combination of the adapter and the 75-ohm cable. This mismatch does not hinder operation, however. Level 'B' is now the 75-ohm reference level (reflection coefficient  $\rho = 0$ ) and level 'C' is now the open-circuit level ( $\rho = 1$ ). The system can be calibrated to read reflection coefficient directly for 75-ohm operation by adjusting the STEP CAL control of the TDR plug-in (screwdriver adjustment) so that the difference between levels 'B' and 'C' is ten centimeters on the display when the REFLECTION COEFFICIENT control is in the ' $\rho/cm = 0.1$ ' position. The REFLECTION COEFFICIENT control is then calibrated for 75-ohm systems instead of for 50-ohm systems.

When the *-hp-* TDR system is operated with a 50-to-75-ohm adapter, the system rise time increases to about 170 picoseconds (instead of 150 ps) and the internal noise level is increased by a factor of 1.5. Other specifications of the TDR system are unchanged. A set of 75-ohm impedance overlays is included with each adapter.

The 50-to-75-ohm adapters may also be used with any signal generator which has a 50-ohm source impedance. The adapter converts the generator into a 75-ohm source so that it can be used in 75-ohm systems without reflections from the source and without any loss of pulse amplitude. If the generator has a calibrated pulse amplitude control, this control retains its calibration when the adapter is used.

— Charles A. Donaldson

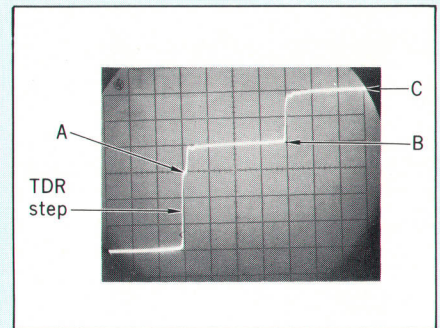
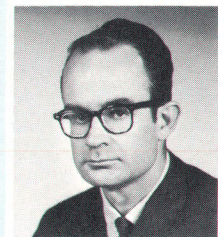

Fig. 3. Oscillogram of TDR display for test setup of Fig. 2, with cable open-circuited ( $Z_L = \infty$ ). Initial reflection at 'A' is due to impedance mismatch between 50-ohm TDR system and 100 ohms of adapter plus cable. Level 'B' is new reference level for 75-ohm measurements (reflection coefficient  $\rho = 0$ ). Level 'C' is open-circuit level ( $\rho = 1$ ).



CHARLES A. DONALDSON

Chuck Donaldson graduated from the University of Colorado in 1962 with a BS degree in electrical engineering and business. After graduation, he spent three years in the evaluation and design of pulse generators and oscilloscope circuitry. Chuck joined *-hp-* in 1965 as an applications engineer, and since then he has been working with the sampling and pulse-generator design groups of the *-hp-* Oscilloscope Division in Colorado Springs.

## RISE TIME CONVERTERS FOR SIMPLER TDR TESTING OF BAND-LIMITED SYSTEMS

TIME DOMAIN REFLECTOMETRY (TDR) is a simple and accurate way to locate and analyze discontinuities in coaxial cables and microwave transmission systems.<sup>1</sup> The time domain reflectometer applies a fast voltage step to the cable or system under test; some of this energy is reflected by discontinuities or changes in the characteristic impedance of the system; then both incident and reflected waves are displayed on an oscilloscope. Because of the finite velocity of electromagnetic waves, discontinuities at different distances from the step generator appear as individual responses on the display, and their locations can be determined easily. The shape and magnitude of each reflection tell what kind of discontinuity is present: resistive, inductive, or capacitive, series or shunt.

The rise time of the incident voltage step in a TDR system is made as short as possible to permit the system to resolve closely spaced echoes and to measure accurately very small reactive discontinuities. In the Hewlett-Packard Time Domain Reflectometer, which consists of the *-hp-* Model 1415A Plug-in with the *-hp-* Model 140A Oscillo-

scope,<sup>2</sup> the rise time of the incident step is less than 120 picoseconds and the overall rise time of the system is less than 150 picoseconds, equivalent to an upper frequency limit of more than 2.3 GHz.

In some cases, however, such as in testing systems which will be operated only in a limited frequency range, a slower rise time can be useful because it provides test conditions which are closer to the actual operating conditions. A common example is a pulse-transmission system for which the pulse rise time is never faster than a given value, say 5 nanoseconds. If the cable is tested using the fast TDR steps ( $t_r =$

0.15 ns), reflections from many reactive discontinuities can appear which would not be of concern in a system designed for a 5 ns rise time. This extra information then makes it more difficult than necessary to clean up the system. If the rise time of the TDR step is slowed to 5 ns, the cable responds in the same way as in actual use, and only discontinuities which affect the operation of the system appear on the TDR display.

### RISE TIME CONVERTERS

With a new series of Rise Time Converters (Fig. 1), the fast rise time of the normal TDR voltage step can be slowed to any of five values between 0.5 nanoseconds and 10 nanoseconds.

The converters are low-pass filters which have been designed for minimum departure of the output step from a Gaussian leading edge and for minimum deviation from a 50-ohm output impedance. The Gaussian leading edge makes the TDR test signal a good compromise in shape and frequency components for the range of signals found in actual operating systems. The 50-ohm output impedance is the same as the output impedance of the reflectometer, which means that unwanted re-reflections are eliminated. Stripline mounting has been used to reduce parasitic effects.

<sup>1</sup> B. M. Oliver, 'Time Domain Reflectometry,' *Hewlett-Packard Journal*, Vol. 15, No. 6, Feb., 1964.

<sup>2</sup> Lee R. Moffitt, 'The Time Domain Reflectometer,' *Hewlett-Packard Journal*, Vol. 15, No. 1, Sept. 1963.

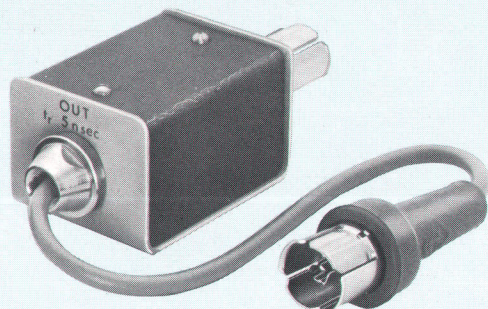

Fig. 1. New rise time converters, *-hp-* Models 10452A to 10456A, slow the rise time of the voltage step in the *-hp-* TDR system to 0.5, 1.0, 2.0, 5.0, or 10.0 nanoseconds to simplify testing of band-limited systems. Rise time of *-hp-* system without converters is 0.15 ns. Shown is 5 ns converter, Model 10455A.

## NEW TDR APPLICATION NOTE

A new application note, 'Selected Articles on Time Domain Reflectometry Applications,' has just been published. This note contains reprints of five articles on uses of TDR which originally appeared as technical reports, papers, and magazine articles. Titles of the articles are

1. Time Domain Reflectometry — Theory and Applications
2. Transmission Line Pulse Reflectometry
3. Mechanical Scaling Enhances Time Domain Reflectometry Use

4. Some Uses of Time Domain Reflectometry in the Design of Broadband UHF Components
5. Thermocouple Fault Location by Time Domain Reflectometry.

Copies of the note may be obtained by requesting Application Note No. 75 from the nearest *-hp-* Field Office or by writing

*Hewlett-Packard  
Colorado Springs Division  
1900 Garden of the Gods Road  
Colorado Springs, Colorado 80907*

The converters are inserted between the STEP OUTPUT and SIGNAL IN connectors of the *-hp-* reflectometer (Fig. 2). Fig. 3a shows a TDR display for a typical cable with the 5-ns converter in

place. The discontinuities that appear are only those that might affect the actual operation of the cable. Once these have been identified, the converter can be removed to make the full resolution of the reflectometer available for accurately locating the troublesome discontinuities (Fig. 3b).

For testing low-pass or band-pass systems, the converters can be used as low-pass filters to attenuate the frequency components of the TDR step which are above the highest frequency of interest. The converters are not designed as filters, so their frequency responses are not specified. However, their bandwidths  $B$  are related to their nominal rise times  $t_r$ , approximately by the relationship  $t_r B = 0.35$ .

The new rise time converters can also be used with any fast-rise-time pulse generator with a 50-ohm output impedance in order to increase the rise and fall times of the output pulse without changing its amplitude or impedance level. The output rise time will be given approximately by

$$t_{r, out} = \sqrt{t_{r, n}^2 + t_{r, g}^2} - .014$$

where  $t_{r, out}$  is output rise time (nanoseconds)

$t_{r, n}$  is nominal output rise time of converter (ns)

$t_{r, g}$  is risetime of generator step (ns).

### ACKNOWLEDGMENTS

Design of the Rise Time Converters was carried out at the *-hp-* Colorado Springs Division by a team consisting of Gene A. Ware, who did much of the electrical design, George H. Blinn, Jr. and Daniel A. Paxton, Jr., who designed the packaging, and the undersigned.

—Lee R. Moffitt

### DESIGN LEADER

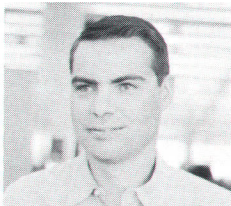

LEE R. MOFFITT

Lee Moffitt graduated from Northwestern University in 1961 with a BSEE degree. He then joined *-hp-* as a circuit design engineer, and participated in the design of the Model 1415A TDR Plug-in. He is now a project leader in the sampling-oscilloscope group of the *-hp-* Colorado Springs Division.

Lee obtained his MSEE degree from Stanford University in 1964 on the Honors Cooperative Program. He is a member of IEEE, Eta Kappa Nu, and Tau Beta Pi.

### SPECIFICATIONS

#### *-hp-* MODELS 10452A - 10456A RISE TIME CONVERTERS

#### OPERATION:

These Converters produce a known rise time step when driven by a fast rise time 50-ohm source. The leading edge of the output wave is approximately Gaussian.

**RISE TIMES:** (10–90% points as measured in 150 ps rise time system)

10452A: 0.5 ns	10454A: 2.0 ns
10453A: 1.0 ns	10455A: 5.0 ns
	10456A: 10.0 ns

**RISE TIME ACCURACY:** ±5% or better

**OVERSHOOT:** Less than ±3%

**OUTPUT IMPEDANCE (dc):** 50 ohms when used with 50-ohm generator.

**OUTPUT MISMATCH:** Less than 5% reflection of step voltage with rise time equal to nominal rise time of converter.

**ALLOWABLE INPUT VOLTAGE:** Up to 50 volts, open circuit, from 50-ohm source.

**CONNECTORS:** GR Type 874

**WEIGHT:** Net, 8 oz. (227 g)

**DIMENSIONS:** 4.5 in. long, 2 in. wide, 1.5 in. high (114,3 x 50,8 x 38,1 mm); 10 in. (254 mm) cable attached.

**PRICE:** *-hp-* 10452A-10456A Rise Time Converters: \$75.00 each.

Prices f.o.b. factory  
Data subject to change without notice

Fig. 3. Oscillograms of TDR displays for typical cable. (a) Since cable will never be used for transmitting pulses with rise times faster than 5 ns, cable is tested with 5-ns rise time converter so that only potentially troublesome reflections appear. (b) Cable response with normal TDR step ( $t_r = 0.15$  ns). Note additional reflections due to faster rise time.

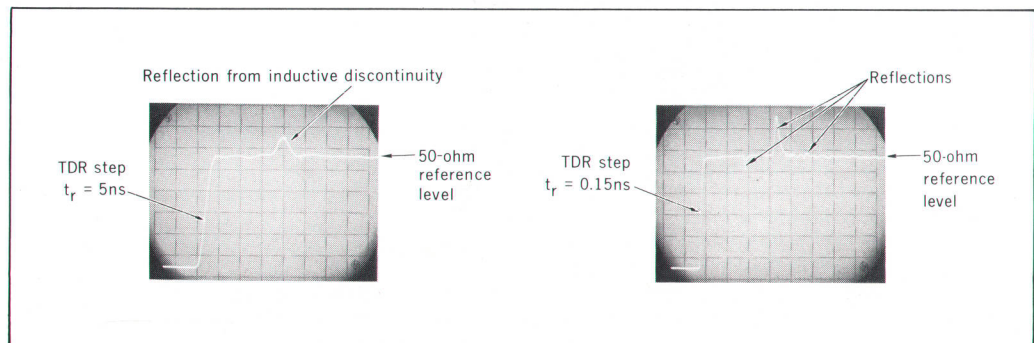

## A CALIBRATED SUSCEPTANCE FOR TDR MEASUREMENTS OF SMALL REACTIVE DISCONTINUITIES

TIME DOMAIN REFLECTOMETRY (TDR), which is described briefly in another article in this issue, uses a pulse-echo technique to locate and characterize impedance discontinuities in cables and microwave devices. TDR offers many advantages over single-frequency or swept-frequency techniques, including its ability to locate reflections accurately and its ability to make accurate measurements of characteristic impedance  $Z_0$  (provided that a known reference is available for comparison).

One important class of discontinuities consists of those which act like small reactances, either series inductances or shunt capacitances, on a transmission system of otherwise constant characteristic impedance. Fig. 1 is a photograph of a typical TDR display, showing the test step and a reflection from a capacitive discontinuity of about 1.5 pF.

Many common reactive discontinuities have capacitances of less than a picofarad or inductances of less than a nanohenry. In such cases the reflection produced by the basic TDR system<sup>1</sup> is

<sup>1</sup> The basic -hp- reflectometer is the Model 1415A TDR Plug-in for the -hp- Model 140A Oscilloscope.

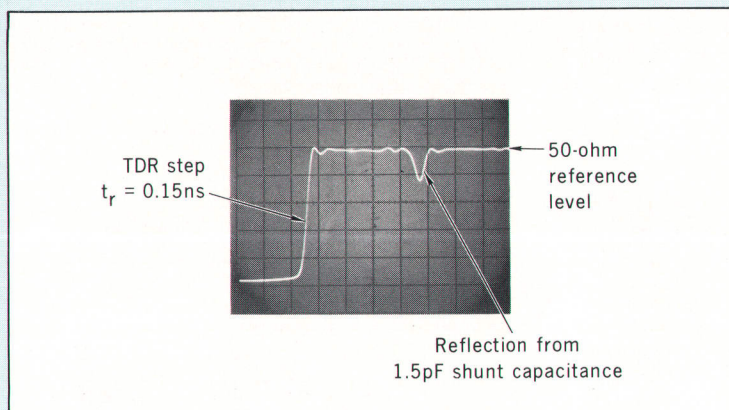

Fig. 1. Oscillogram of typical TDR display showing test step ( $t_r = 0.15$  ns) and reflection from capacitive discontinuity of about 1.5 pF.



Fig. 2. -hp- Model 874A Calibrated Susceptance simplifies TDR measurements of small reactive discontinuities. Susceptance provides basis for comparison measurements of capacitive discontinuities from 0 to 1 pF and inductive discontinuities from 0 to 2.5 nH.

non-ideal, because these small reactances respond only slightly to the non-zero rise time of the test step ( $t_r$  for the basic -hp- TDR system is 0.15 ns). Inductance, capacitance, reflection coefficient, and standing wave ratio for these small reactive discontinuities have in the past been measured either by means of approximate TDR techniques or by means of conventional frequency-domain devices like the slotted line. Both of these methods are somewhat tedious and inaccurate.

It is now no longer necessary to resort either to frequency-domain techniques or to approximations when small reactive discontinuities are encountered. The accuracy of TDR meas-

urements of reactive discontinuities can be greatly enhanced by using a calibrated reactance as a comparison standard, and a new calibrated susceptance (Fig. 2) has recently been developed for this purpose. A standard reactive reflection is realized by placing a calibrated variable shunt capacitance in a section of precision air-dielectric coaxial line. The capacitance between center conductor and probe is indicated by a hairline on a dual scale, which is calibrated by a high-resolution bridge technique to read either capacitance or inductance. The calibrated susceptance has a capacitance range of 0 to 1 picofarad, and an inductance range of 0 to 2.5 nanohenries; most reactive discontinuities are in these ranges.

### CAPACITANCE AND INDUCTANCE MEASUREMENTS

A measurement of an unknown reactance is made by placing the calibrated susceptance and the unknown in tandem in a conventional TDR setup (Fig. 3). If the unknown reflection is capacitive, the calibrated susceptance is adjusted until it causes an equal negative-going deflection on the display (Fig. 4). The unknown capacitance is then read directly on the capacitance scale of the calibrated susceptance. If the unknown reflection is

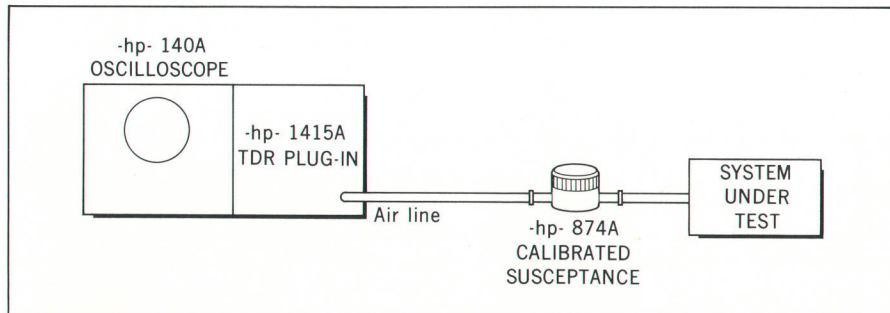

Fig. 3. Block diagram showing Calibrated Susceptance in typical TDR setup.

inductive, the calibrated susceptance is adjusted to give an equal but opposite deflection, and the unknown inductance is read on the inductance scale. Since the measurement is comparative, the inductance or capacitance of the discontinuity can be measured accurately even if the TDR system has a relatively slow rise time, and even if the rise time changes because of losses in connection lines and cables.

#### REFLECTION COEFFICIENT CALCULATIONS

Reactive discontinuities generally act like lumped inductances or capacitances which do not vary with frequency. In such cases, the reflection coefficient  $\rho$  and the standing wave ratio SWR can be calculated over a wide range of frequencies on the basis of a single measurement of  $L$  or  $C$  made with the calibrated susceptance. The complex reflection coefficient as a function of the complex frequency  $s$  is, for a shunt capacitance on a transmission line of characteristic impedance  $Z_0$ ,

$$\rho(s) = \frac{-s}{s + \frac{2}{Z_0 C}}$$

and for a series inductance,

$$\rho(s) = \frac{s}{s + \frac{2Z_0}{L}}$$

where  $s = j2\pi f$  for real frequencies  $f$ .

The standing wave ratio is

$$SWR = \frac{1 + |\rho(s)|}{1 - |\rho(s)|}$$

The value of the characteristic impedance  $Z_0$  to be used in these formulas can also be determined by a comparison measurement with the calibrated susceptance, which has a characteristic impedance of 50 ohms  $\pm 0.1$  ohm. Thus all of the important information about reactive discontinuities can be obtained, with an accuracy previously impossible, by adding to the TDR system a single inexpensive device.

#### ACCURACY

Capacitance measurements made with the calibrated susceptance are accurate within  $\pm 0.005$  picofarads or 5%  $C$ , whichever is greater, for values of  $C$  between 0 and 0.5 pF. Useful range is 0 to 1 pF but the scale is roughly logarithmic, becoming more compressed at the high end. Thus for values of  $C$  above 0.5 pF, the width of the hairline limits the accuracy with which the scale can be read. However, nearly all of the

capacitive discontinuities usually encountered lie between 0.01 and 0.15 pF.

Inductance measurements are accurate within  $\pm 0.013$  nanohenries or 5%  $L$ , whichever is greater, for values of  $L$  between 0 and 1.3 nH. Useful range is 0 to 2.5 nH.

—Richard W. Anderson

#### DESIGN LEADER

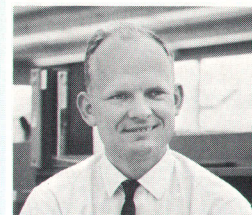

RICHARD W. ANDERSON

Dick Anderson joined -hp- in 1959 as a development engineer in the -hp- Microwave Division. His first project was the 851A/8551A Spectrum Analyzer and accessories. Since then, he has worked on a variety of microwave devices ranging from solid-state oscillators to wide-band high-precision directional couplers. He was project engineer for development of the 874A Calibrated Susceptance. His present position is engineering section manager, -hp- Microwave Laboratory.

Dick received his BSEE degree from Utah State University in 1959, and his MSEE degree from Stanford University in 1963. He is the author of several technical papers and has several patents pending. He is active in the IEEE Microwave Theory and Techniques Group.

#### SPECIFICATIONS

##### -hp- MODEL 874A CALIBRATED SUSCEPTANCE

**CAPACITANCE RANGE:** 0 to 1 pF  
**ACCURACY:**  $\pm 0.005$  pf or 5%  $C$ , whichever is greater,  $0 < C < 0.5$  pF

**INDUCTANCE RANGE:** 0 to 2.5 nH  
**ACCURACY:**  $\pm 0.013$  nH or 5%  $L$ , whichever is greater,  $0 < L < 1.3$  nH

**CHARACTERISTIC IMPEDANCE:** 50 ohms  $\pm 0.1$  ohm

**CONNECTORS:** GR874

**LINE LENGTH:** 17.4 cm

**WEIGHT:** Net, 1 lb. (0.45 kg); Shipping, 2 lb. (0.9 kg)

**DIMENSIONS:** (Maximum envelope):  $7\frac{1}{2}$  in. long,  $2\frac{3}{8}$  in. wide,  $2\frac{1}{2}$  in. high (191 x 73 x 64 mm)

**PRICE:** -hp- 874A Calibrated Susceptance \$250.00

Prices f.o.b. factory  
 Data subject to change without notice

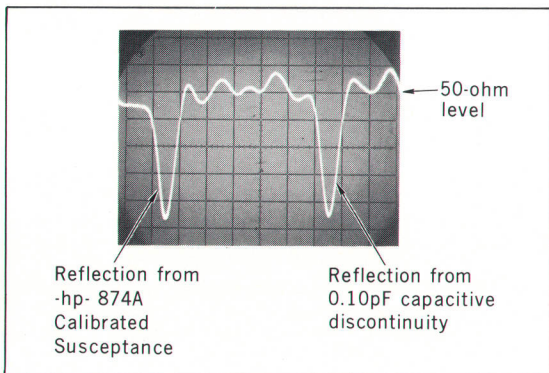

Fig. 4. Oscillogram of portion of TDR display (step not shown) with expanded horizontal and vertical scales, showing reflection from Calibrated Susceptance ( $l$ ) and reflection from capacitive discontinuity of 0.10 pF ( $r$ ). Discontinuity was diode across coaxial line. Setup was as in Fig. 3.

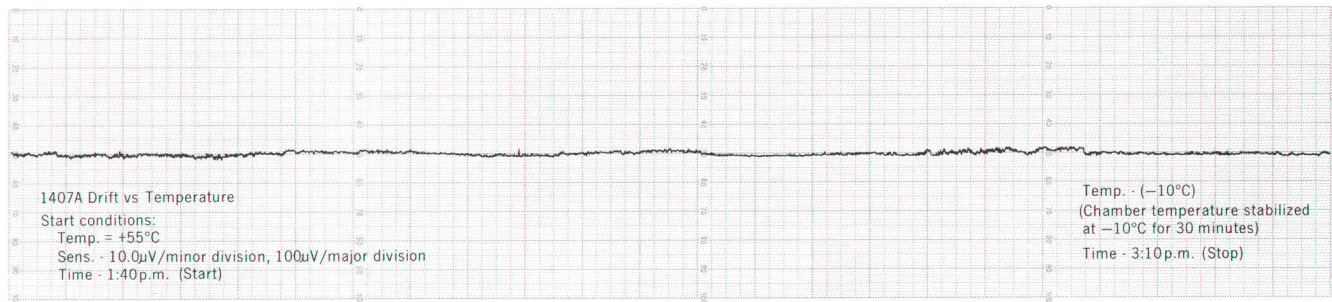

Fig. 3. Strip chart recording shows insensitivity of plug-in stabilized dc level to variations in temperature. At start of recording scope was in environmental chamber at 55°C. Chamber temperature was reduced to -10°C over period of 1 hour and then held at that temperature for remaining 1/2 hour of test. Trace deviates less than  $\pm 20 \mu\text{V}$  during test.

## STABILIZED PLUG-IN UNIT

(continued from back cover)

scale measurements. In addition, the plug-in amplifier was designed with a wide dynamic range ( $\pm 50 \text{ cm}$ ) allowing detailed examination of any part of a waveform with high magnification, as shown in the photos of Fig. 6.

### WIDE RANGE OFFSET

A separate Offset control on the plug-in enables input dc levels to be bucked out. It is thus possible to retain dc coupling while the waveform is magnified for high sensitivity. For example, small mechanical movements sensed by strain gages can be examined on the oscilloscope, using the offset to buck out any dc unbalance component of the signal, the high sensitivity to provide detail in the waveform, and the dc stability to provide confidence in the results. Or, it is possible to make such measurements as the determination of both the ac and dc components of small base currents in transistor cir-

cuits (using the series resistor current-measuring technique).

The Offset control enables the zero voltage level to be displaced as much as  $\pm 200$  screen diameters ( $\pm 2000 \text{ cm}$ ) from center screen on the most sensitive range and by at least  $\pm 50 \text{ cm}$  on less sensitive ranges. The offset voltage is stable within  $20 \mu\text{V/hr}$  and changes less than  $\pm 100 \mu\text{V}$  in a temperature change of 0 to 55°C.

### DIFFERENTIAL INPUT

Other measures were taken in the design of the new plug-in to enhance the usefulness of the  $50\text{-}\mu\text{V/cm}$  sensitivity. For example, the input is differential. The plug-in thus can be driven by balanced sources and it has excellent rejection of common-mode signals, 80 dB from dc to 60 Hz for instance. The common ground at the input may be disconnected from the internal circuit ground so that it can be driven by a common-mode voltage from a low source impedance to increase the common-mode input impedance, thus reducing the effects of unbalance source impedance. A front-panel control enables optimization of amplifier gain balance for best common-mode rejection.

Common-mode signals up to  $\pm 7.5 \text{ V}$  have no effect on the wide dynamic range of the plug-in. Common-mode signals higher than that affect dynamic range by driving the amplifier towards a non-linear operating point but the plug-in is still capable of dynamic ranges greater than the  $\pm 20 \text{ cm}$  of conventional oscilloscopes. For example, a dynamic range of typically  $\pm 34 \text{ cm}$  is possible with a CM voltage of  $\pm 10 \text{ V}$ .

To permit the use of a differential input, the offset and drift correction voltages are applied to the amplifier independently of the input. The offset may thus be used in differential measurements. (Transients at the input during the stabilization interval have been minimized by the use of a high-quality chopper relay, with good isolation from the drive signal, to decouple the input during stabilization).

### NOISE FILTERING

The practicality of high sensitivity is further enhanced by a switchable low-pass filter that reduces noise in the

### DESIGN LEADERS



PETTIT



SCHROATH

Jim Pettit joined -hp- in 1962 following graduation as a BSEE from Utah State University. Two years later, he earned his MSEE degree from Stanford University in the -hp- Honors Cooperative Program. At -hp-, Jim initially was the development engineer on the 1754A Four-Channel Amplifier for the Model 175A Oscilloscope. Since that time, he has been associated with 140A/141A Oscilloscope program. He is at present a project leader in that group.

Tom Schroath spent four years in the U.S. Air Force and two years as an air-conditioning engineer before earning his BSEE degree from Brigham Young University in 1963. Following graduation, he worked with an aircraft company and then joined -hp- in 1965 as a product designer on the 155A/1550A Programmable Oscilloscope. At present, he is a product designer in low frequency Oscilloscopes.

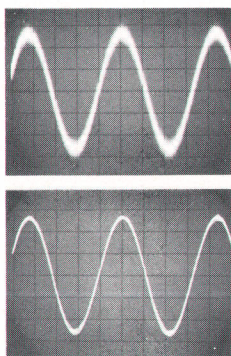

Fig. 4. Bandwidth filter improves resolution of low-level, low-frequency waveforms. Photo of 500-Hz sine wave at top was made on  $50\text{-}\mu\text{V/cm}$  range with full bandwidth (300 kHz at  $50 \mu\text{V/cm}$ ). Lower photo is of same waveform with bandwidth cut off at 5 kHz.

plug-in by limiting the passband to no more than that required by the signal. The filter has four positions, cutting off at 400 kHz (300 kHz on the 50  $\mu$ V/cm range), 100, 25, and 5 kHz. Using the filter to reduce noise in the display improves the resolution of the measurement (Fig. 4).

#### STABILIZER OPERATION

The dc stabilizer in the new plug-in is similar in concept to the stabilizer in the *-hp-* Model 155A Programmable Oscilloscope, described on page 4. Normally, the stabilizer corrects for drift 3

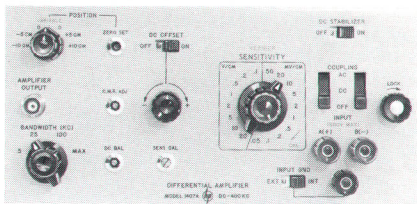

Fig. 5. Model 1407A Differential Amplifier plug-in has independent Position and Offset controls. Offset, used to buck out input dc levels over wide range, can be switched out for checking zero reference level on scope without disturbing control setting. Positioning is either continuous or by calibrated steps, for convenience in expanded scale measurements.

#### SPECIFICATIONS

*-hp-*  
MODEL 1407A  
DIFFERENTIAL AMPLIFIER

**DEFLECTION FACTOR (SENSITIVITY):** 50  $\mu$ V/cm to 20V/cm in 1, 2, 5 sequence. Vernier provides continuous adjustment between ranges and extends deflection factor to at least 50 V/cm. Attenuator accuracy is  $\pm 3\%$ .

**AMPLIFIER OUTPUT:** Approximately 1 V/cm, dc-coupled, single-ended; dc level approximately 0 V, dynamic range is  $\pm 5$  V. Output impedance less than 100 ohms. With stabilizer operating, output signal is dc-stabilized and contains 5-ms transients at stabilizer repetition rate.

#### BANDWIDTH:

Maximum Upper Limit:  
20 V/cm to 100  $\mu$ V/cm ranges — 400 kHz, (0.9  $\mu$ s risetime)  
50  $\mu$ V/cm range — 300 kHz.

Upper limits of 100, 25, and 5 kHz selectable with front panel switch on all sensitivities.

Lower Limit: dc with input dc coupled; 2 Hz with input ac coupled.

#### DRIFT:

Long-term drift: Less than  $\pm 0.2$  cm or less than  $\pm 20$   $\mu$ V, whichever is greater, per 200 hrs.

times per second but with slow sweeps or in the absence of sweep operation, the stabilizer is self-triggering at a rate of 1½ times per second (the trace is blanked during the stabilization interval). The plug-in may therefore be used independently of a time base. Stabilized X-Y displays are thus possible using a pair of these plug-ins to drive both the horizontal and vertical channels of a scope.

Automatic stabilization in the absence of a sweep also enables single-sweep measurements, with full confidence that no errors will creep into the measurement because of vertical amplifier drift during the waiting time before the sweep is triggered (there is only a 1% probability that the stabilizer and concurrent sweep hold-off will be cycling at the instant of triggering).

#### AMPLIFIER OUTPUT

A front-panel output connector is provided so that the plug-in may also serve as a sensitive stabilized preamplifier for other equipment. Maximum gain from the input to the front panel jack is 20,000. The signal at the output jack is periodically interrupted by the stabilization switching signals that ground and rezero the amplifier but these vary with the amplifier sensitivity

Temperature drift: Less than  $\pm 0.2$  cm or less than  $\pm 50$   $\mu$ V, whichever is greater, over temperature range of 0°C to 55°C.

Drift correction occurs at 3 Hz for 50 ms/cm sweeps and faster, and 1.5 Hz on 0.1 s/cm sweeps and slower.

**RANGE TO RANGE SHIFT:** dc stabilization maintains fixed baseline reference within  $\pm 1$  cm on CRT over entire range of sensitivity after 3-minute warmup.

**POSITIONING:** Baseline can be positioned  $\pm 10$  cm by continuous positioning or in calibrated steps of 0,  $\pm 5$  cm, and  $\pm 10$  cm. Calibrated positioning accuracy is  $\pm 3\%$ .

**DC OFFSET:** Uncalibrated dc offset is provided in both single-ended and differential operation. Maximum amount of offset obtainable, referenced to input, varies with sensitivity approximately as follows:  $\pm 0.1$  V at 50  $\mu$ V/cm, increasing to  $\pm 0.5$  V at 10 mV/cm, to  $\pm 5$  V at 100 mV/cm, to  $\pm 50$  V at 1 V/cm, and to  $\pm 600$  V at 20 V/cm. Offset dc drift is less than  $\pm 20$   $\mu$ V/hr at constant ambient temperature or less than  $\pm 100$   $\mu$ V for ambient temperature change of 0°C to +55°C.

**DIFFERENTIAL INPUT:** May be selected on all attenuation ranges; offset capability is maintained in differential operation.

**COMMON MODE REJECTION** ( $\pm 5$  V peak input, 50  $\mu$ V/cm to 50 mV/cm ranges dc-coupled):  
dc to 60 Hz — 80 dB  
60 Hz to 10 kHz — 60 dB

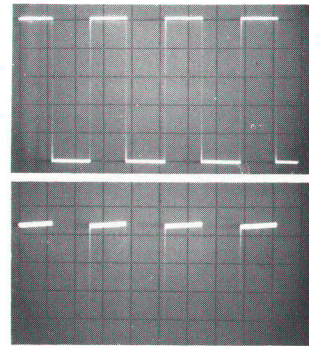

Fig. 6. Plug-in enables expanded displays without distortion. Upper photo shows normal presentation of 50-kHz square wave at 10 mV/cm. Lower photo is of same waveform, expanded vertically to 50 cm and offset downward.

setting. For applications not requiring dc stabilization, the stabilizer may be switched off to eliminate the switching transients.

#### ACKNOWLEDGMENTS

Product design of the *-hp-* Model 1407A Differential Amplifier was by Thomas Schroath and circuit design was by the undersigned. Basic design concepts and many valuable suggestions were contributed by John Strathman, Group Leader for low-frequency oscilloscope development in the *-hp-* Colorado Springs Division.

—James R. Pettit

Maximum Common-mode plus Signal Input (without overload):

50  $\mu$ V/cm to 20 mV/cm —  $\pm 10$  V peak  
50 mV/cm to 2 V/cm —  $\pm 100$  V peak  
5 V/cm to 20 V/cm —  $\pm 600$  V peak

**DYNAMIC RANGE:** Dynamic signals up to  $\pm 50$  cm of deflection can be displayed without distortion.

**INPUT IMPEDANCE:** 1 megohm shunted by 90 pF, constant on all attenuator ranges.

**MAXIMUM INPUT:** 600 volts (dc + peak ac).

**X-Y OPERATION:** Two 1407A's can be used to give stabilized X-Y presentations. Internal 'X-Y NORMAL' switch enables plug-ins to synchronize stabilizing cycles.

**TIME BASE COMPATIBILITY:** Model 1407A can be used directly with Models 1422A and 1423A Time Bases; 1420A's below serial 441-01326 and 1421A's below serial 545-00651 must be modified for use with 1407A (use kit 01420-69502 for 1420A and kit 01421-69501 for 1421A).

**WEIGHT:** Net, 5 lbs. (1,8 kg). Shipping, 7 lbs. (3,2 kg).

**PRICE:** \$625.00.

Price f.o.b. factory

Data subject to change without notice

# A DC-STABILIZED OSCILLOSCOPE PLUG-IN WITH 50- $\mu$ V/CM SENSITIVITY

Freedom from dc drift overcomes one of the most troublesome effects in making oscilloscope measurements of transducer output and other small signals.

MANY IMPORTANT WAVEFORM MEASUREMENTS, such as transducer measurements, require accurate retention and display of dc levels. Because of the inherent drift of dc-coupled amplifiers, oscilloscope measurements concerned with dc levels have often been inaccurate, or at least difficult. For this reason, the sensitivity of dc-coupled oscilloscopes has been limited, the state-of-the-art permitting a typical deflection factor of 100  $\mu$ V/cm.<sup>1</sup>

Drift has now been reduced to negligible levels by a dc stabilizer in a new 400-kHz vertical channel plug-in for two of the *-hp-* Oscilloscopes (Models 140A and 141A). Because of the reduction of drift, it was practical to make the minimum deflection factor of the plug-in 50  $\mu$ V/cm, a sensitivity well-suited for transducer monitoring and for other low-level measurements that require retention of a dc reference level.

With drift practically eliminated, the trace stays in the desired screen posi-

tion indefinitely. Sensitive oscilloscope measurements of dc levels therefore can be made with confidence with the new plug-in (*-hp-* Model 1407A).

## DC STABILITY

Long term stability of the new plug-in is illustrated by the photos of Fig. 2, made while the plug-in was operated with a deflection factor of 50  $\mu$ V/cm in the dc-stabilized mode. The photos were taken 65 hours apart and show no detectable drift during this time interval. The new plug-in operated in the 140A/141A Oscilloscopes has a long-term drift of less than  $\pm 20$   $\mu$ V or  $\pm 0.2$  cm, whichever is greater, per 200 hours of operation. This is equivalent to only 0.1  $\mu$ V/hr.

The plug-in has low sensitivity to temperature variations. The recording of Fig. 3 was made with a typical instrument during an ambient change from  $+55^{\circ}\text{C}$  to  $-10^{\circ}\text{C}$  in a 1½ hour time interval and indicates a drift of less than  $\pm 20$   $\mu$ V, once more showing that measurement uncertainties resulting from drift in low-level measure-

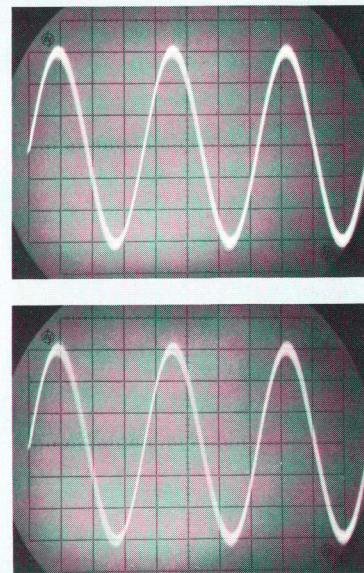

Fig. 2. Oscillograms, made with Differential Amplifier plug-in operating while dc-coupled on most sensitive range (50  $\mu$ V/cm), demonstrate absence of drift over extended periods. Time elapsed between first and second oscillograms was 65 hours but there is no discernible drift in dc level of CRT trace.

ments are practically eliminated by this plug-in. Ambient temperature variations throughout a range from 0 to  $55^{\circ}\text{C}$  cause dc drift of less than  $\pm 50$   $\mu$ V or  $\pm 0.2$  cm, whichever is greater.

## CALIBRATED POSITIONING

The stabilized dc performance of the plug-in makes it feasible to use calibrated vertical positioning. The positioning circuit was designed to permit either continuous or stepped control, stepped control permitting the zero level to be displaced from center screen by  $\pm 5$  or  $\pm 10$  cm with an accuracy of 3% for more convenience in expanded

(continued inside on page 14)

<sup>1</sup> John Strathman, 'Long-term Stability of the *-hp-* Model 130C Sensitive DC-500 KC Oscilloscope', 'Hewlett-Packard Journal', Vol. 15, No. 5, Jan., 1964

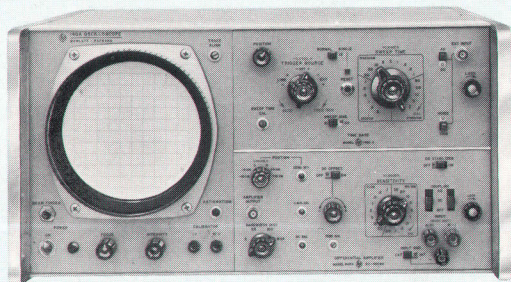

Fig. 1. New *-hp-* Model 1407A Differential Amplifier Plug-in (in lower plug-in compartment) works with either Model 140A General Purpose Oscilloscope or Model 141A Variable Persistence Oscilloscope. DC stabilization of plug-in amplifier eliminates drift problems, enabling use of dc coupling with deflection factors as low as 50  $\mu$ V/cm. Plug-in has upper frequency limit of 400 kHz.